

# EVEREADY®

LED Lighting Solutions



Date

Project

Type

## Canopy

## PGCR-80W-277-F10-50K

### FEATURES

Model #:	PGCR-80W-277-F10-40K	PGCR-80W-277-F10-50K
CCT:	4000 K	5000 K
Light Output:	10117.8 lm	10206.4 lm
Efficacy (AC):	132.95 lm/W	133.4 lm/W
Wattage:	80 W	
Beam Angle:	110°	

Voltage:	120-277 Vac
Light Source Type:	SMD3030
CRI:	>73 Ra
Working Temperature:	-40-104° F
Power Factor:	0.938
THD:	<17.5%

### Order Information



**PGCR**

- P - Parking
- G - Garage
- C - Canopy
- R - Round



**Wattage**

- 40 W
- 60 W
- 80 W



**Input Voltage**

277: 100-277 Vac



**F10**

- F - Flat
- 1 - With sensor
- 0 - W/O backup battery



**CCT**

- 40 K - 4000 K
- 50 K - 5000 K

### Lux Chart/Photometrics

3.28ft	3460.1 lx	10.20 ft
6.56ft	865.0 lx	20.40 ft
9.84ft	384.5 lx	30.60 ft
13.12ft	216.3 lx	40.80 ft
16.4ft	138.4 lx	51.00 ft
19.68ft	96.1 lx	61.20 ft
22.97ft	90.6 lx	71.40 ft
26.25ft	54.1 lx	81.60 ft
29.53ft	42.7 lx	91.80 ft
32.81ft	34.6 lx	102.00 ft

Max , Ave Beam angle of C247plane1 14.46

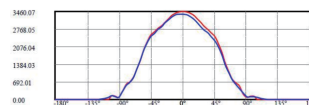
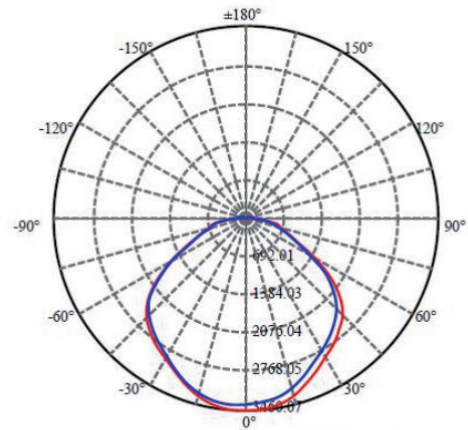

C0/C180: —  
 C90/C270: —  
 Field angle(10%Imax):C0/180Left:84.5 Right:83.1  
 :C90/270Left:79.6 Right:87.6  
 Beam Angle(50%Imax):C0/180Left:57.9 Right:56.4  
 :C90/270Left:53.5 Right:60.9

ETL Listing: 4007551



DLC Primary Use: Fuel Pump Canopy Luminaires



**IESNA LM-79 & IESNA LM-80 Testing:**

This product has been tested by an independent laboratory in accordance with IESNA LM-79 and 80, and have received the department of energy" lighting facts" label.

**White Finish:**

Environmentally friendly polyester powder coatings are formulated for high-durability and long-lasting color, and contain no VOC or toxic heavy metals.

**Green Technology:**

Mercury and UV free RoHS compliant components Polyester powder coat finish formulated without the use of VOC or toxic heavy metals.

**Lifespan:**



50,000-hour LED lifespan based on IES LM-80 results and TM-21 calculations.

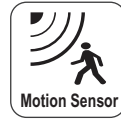

**LED Characteristics**

LEDs: Top grade LED, high-output, long-life

**Color Stability:** Comply with DLC's requirements.

**Color Uniformity**

CCT (Correlated Color Temperature) follows the guidelines of the American National Standard for Specifications for the Chromaticity of Solid State Lighting (SSL) Products, ANSI C78.377-2015.

**Driver:**

Class 2, IP65, Constant Current, 100-277V, 50-60Hz, 4KV surge protector inside of power supply

**Dimension:**

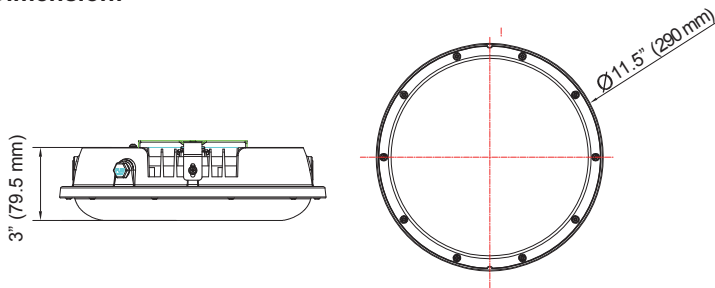

Weight: 9.6 Lbs (4.3 Kg)

**Housing:**



Heavy-duty cast aluminum housing; rust and corrosion proof; polyester powder coating

High light transmittance & Polycarbonate with UV

**Installation:**

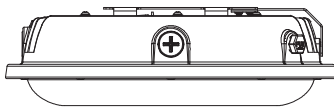

Surface mount

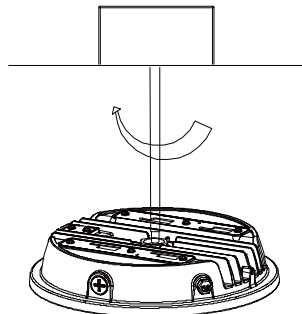

Conduit mount

**Show Details:**

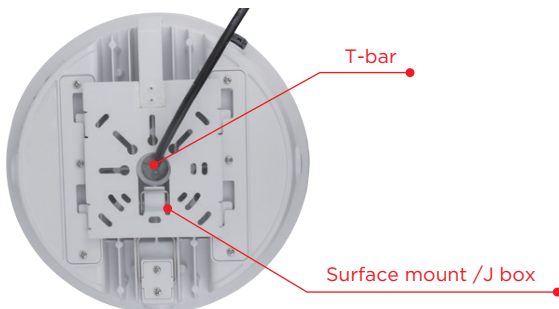

T-bar

Surface mount / J box



Security hook attached